

Heaty Racun 100 Advanced

Conditioning unit



150eX

1	Introduction	6
1.1	The Racun 100 Advanced	6
1.2	Conditions of use	6
1.3	Target group	7
1.4	Conventions	8
1.5	Manufacturer's address	9
2	Safety instructions	10
2.1	General information	10
2.2	Intended use	10
2.3	Improper use	12
2.4	Hazards during transport and installation	12
2.4.1	Transport	12
2.4.2	Installation	12
2.5	Hazards during operation and maintenance	13
2.5.1	Mechanical hazards	13
2.5.2	Hazards due to hot surfaces	14
2.5.3	Hazards due to electric current	14
2.5.4	Dangers when handling the circulation pump	15
2.5.5	Hazards due to operating fluids	15
2.6	Personal protective equipment	16
2.7	Warning and information signs	16
3	Device description	17
3.1	Overview of the Racun 100 Advanced	18
3.2	Circulating water inlet	20
3.3	Filter capacity indicator	20
3.4	Magnetic flux filter	20
3.5	Circulation pump	20
3.6	Circulating water output	20
3.7	Control unit	20
3.8	Cartridge	24
3.9	Fine filter	24
3.10	Changeover valve	25

3.11	Output filter cartridge	25
3.12	Solenoid valve	25
3.13	Filling/replenishment connection	25
4	Transport, installation and commissioning	26
4.1	Transport	26
4.2	Installation and commissioning	26
5	Operation	30
5.1	Making settings in the control unit	30
5.1.1	Starting the system	30
5.1.2	Filling the system	30
5.1.3	Operating parameters	30
5.1.4	Configuration	31
5.1.5	Removing the card	33
5.2	Operating Racun 100 Advanced	34
5.3	Switching off Racun 100 Advanced in an emergency	37
5.4	Switching off Racun 100 Advanced	37
6	Maintenance and servicing	38
6.1	Maintenance schedule	38
6.2	Maintenance work	40
6.2.1	Changing the mixed bed resin	40
6.2.2	Cleaning the magnetic flux filter	42
6.2.3	Changing the fine filter	42
6.3	Regular internal inspection	43
6.4	Spare parts and accessories	44
7	Disassembly and disposal	45
7.1	Specialised personnel	45
7.2	Disassembly	46
7.3	Disposal	46
8	Technical data	47
8.1	General data	47
8.2	Components	48
8.2.1	Magnetic flux filter	48
8.2.2	Circulation pump	48

9	Applicable documents	49
9.1	Measured values and conversion tables	49
9.1.1	Corrosion rate	49
9.1.2	Limescale content and water hardness	50
9.2	Magnetic flux filters	52
9.2.1	Drawings	52
9.2.2	Characteristic curve	53
9.2.3	Cleaning	54
9.3	Quick guide to the changeover value	55
9.4	Control terminal diagram	57
9.5	Terminal diagram for measuring probes LF1/LF2	57
10	List of illustrations	58

1

Introduction

1.1 The Racun 100 Advanced

The Heaty Racun 100 Advanced is a treatment device for the permanent installation and initial filling of heating systems and cooling systems (without inhibitors) with water, for the permanent treatment of water in heating systems and cooling systems (without inhibitors) using the bypass method.

RACUN stands for **R**ichtig **A**ufbereiten **C**hemiefrei **U**nd **N**ormgerecht

The Racun 100 Advanced also fulfils the following tasks:

- Make-up monitoring
- Magnetite filtering
- Sludge and fine filtering
- Conductivity monitoring
- Pressure-controlled replenishment (in conjunction with a filling combination)

If the Racun 100 Advanced is not used as intended, this may result in personal safety hazards and poor quality process results.

Please read these operating instructions carefully and take note of the safety, operating and maintenance instructions.

1.2 Conditions of use

To use the Racun 100 Advanced properly, observe the following instructions:

- Before starting work, make sure that the heating or cooling system corresponds to the recognised state of the art.
- Observe the regulations on the construction, commissioning, design and filling of heating and cooling systems.
- When filling heating and cooling systems, operate the Racun 100 Advanced with a flow pressure systems with a flow pressure of at least 1.5 bar in the drinking water pipe.
- During water treatment or initial filling of a heating or cooling system without a bypass process, fully demineralised water (demineralised water) may cause existing deposits to be removed. Any resulting damage is due to the existing deposits.

- Ensure that there is an additional shut-off device at both the inlet and outlet of the circulating water.
- Always flush and clean heating and cooling systems in accordance with DIN EN 14336 if you are not using the Racun 100 Advanced in bypass mode.
- The manufacturer does not guarantee compliance with the reference values if additives such as glycols, acids and cleaning agents or bacteria are present in the system.
- If there is a risk of frost, completely drain the residual water from the Racun 100 Advanced after work to protect it from damage.
- The installer is responsible for preparing and handing over the documentation in accordance with the relevant country-specific guidelines (e.g. VDI 2035, Ö-Norm H 5195-1 or SWKI BT 102-1). The operator is responsible for maintaining the documentation.
- If the temperature difference between the room temperature and the cooling water in cooling systems is too great (condensate), insulation must be provided on site.

1.3 Target group

These operating instructions are intended for persons who work with or on the Racun 100 Advanced:

- Operating personnel
- Maintenance and servicing personnel

Qualifications of the target group

The target group of the operating instructions must have at least the following qualifications:



- Operating personnel: **Instructed person**
An instructed person is a person who has been informed about the assigned tasks and the possible dangers of improper behaviour.
 - uninstructed,
 - trained if necessary and
 - has been instructed on the necessary safety equipment and protective measures.
- Maintenance and servicing personnel: **Specialist**
A specialist is a person who is able to assess the work assigned and recognise potential hazards based on their specialist training, knowledge and experience as well as knowledge of the relevant regulations.

1.4 Conventions

Warnings and other instructions

In the operating instructions, instructions are weighted differently and labelled with a pictogram.

Warnings are structured as follows:

Symbol	Signal word	Meaning
	DANGER	Warning notice: Immediate danger. Death or severe injuries <u>are</u> the consequence..
	WARNING	Warning notice: Potentially dangerous situation. Death or very serious injuries <u>may</u> result.
	CAUTION	Warning notice: Potentially dangerous situation. Slight or minor injuries <u>may</u> result.
	NOTE	Note: Information that must be observed to ensure optimum results and safe operation of the system.

- **Signal word**
Indicates the severity of the hazard.
- **Type and source of danger**
Indicates the danger being warned of and where it may occur.
- **Cause and effect**
Describes the cause of the hazard or damage and its effect.
- **Remedy**
Describes how the hazard can be prevented from occurring.

Example of a warning notice



DANGER

Risk of injury from improper use

Improper use of the Racun 100 Advanced can endanger persons and property.

- Only use the Racun 100 Advanced for its intended purpose as described below.
-

Handling instructions

Handling instructions are numbered to indicate the sequence of the individual steps. The results of the actions (if any) are shown directly below.

Example:

- 1 This is the first step.
- 2 This is the second step.
 - ▶ This is the result of the second step.

Operating and control elements

Operating elements, e.g. buttons and switches, and control elements, e.g. buttons on the control panel, are marked in **bold**.

Example: The **emergency stop button** is located on the control panel.

1.5 Manufacturer's address

UWS Technologie GmbH

Sudetenstraße 6
91610 Insingen
GERMANY

Internet : www.uws-technologie.de

E-mail : info@uws-technologie.de

Phone : +49 9869 91910-0

Fax : +49 9869 91910-99

2

Safety instructions

The Heaty Racun 100 Advanced has been designed and manufactured in compliance with applicable legal regulations and in accordance with recognised safety standards. The Racun 100 Advanced corresponds to the state of the art at the time of its initial commissioning.

Nevertheless, hazards may arise for the operator, for other persons, for the Racun 100 Advanced itself and for other material assets.



NOTE

For safe handling of the Racun 100 Advanced, observe the safety instructions in this section and the warnings in other sections of these operating instructions.

2.1 General information

The Racun 100 Advanced may only be set up, operated and maintained by specialised personnel trained in safety technology.

Persons involved in the commissioning, operation, maintenance, repair, dismantling and disposal of the Racun 100 Advanced must have read and understood the operating instructions and in particular the safety instructions.

The operating instructions must be kept in a safe place and be available at all times to persons working with or on the Racun 100 Advanced.

2.2 Intended use

In order to use the Racun 100 Advanced as intended, it is necessary to be familiar with the operating instructions and to comply with all instructions, maintenance and inspection regulations contained therein.



DANGER

Danger to life or risk of serious injury

There are mechanical and electrical hazards when operating the Racun 100 Advanced. To prevent personal injury due to these hazards, the Racun 100 Advanced may only be used as intended.

The Racun 100 Advanced may only be used as intended as follows:

For the initial filling of heating systems and cooling systems (without inhibitors) with water and for the permanent treatment of water in heating systems and cooling systems (without inhibitors) using the bypass method. The following additional specifications apply:

- **Heating and cooling systems**

The Racun 100 Advanced is intended for heating and cooling systems (without inhibitors) in larger residential and industrial buildings. Various device types are available, which must be selected depending on the size of the system (see section „8 Technical data“ on page 47).

- **Other tasks**

In addition to initial filling and treatment, the Racun 100 Advanced fulfils the following additional tasks:

- Replenishment monitoring
- Magnetite filtering
- Sludge and fine filtering
- Conductivity monitoring
- Pressure-controlled replenishment (in conjunction with a filling combination)

- **Filling**

The Racun 100 Advanced may only be filled with the mixed bed resin Vadion pH-Control.

- **Operation**

The Racun 100 Advanced may only be operated and maintained by persons who are sufficiently qualified and authorised.

- **Safety equipment**

The Racun 100 Advanced may only be operated with intact safety devices. Safety equipment must be checked regularly for correct condition and proper function.

- **Maintenance and servicing**

General inspection and cleaning work must be carried out by trained personnel. Maintenance, servicing and repair work must only be carried out by qualified specialists.

2.3 Non-intended use

The Racun 100 Advanced may only be used in the ways described in section „2.2 Intended use“ on page 10. Any other use may endanger persons and property and is prohibited.

Non-intended uses include, but are not limited to:

- Use for purposes other than the initial filling of heating systems and cooling systems (without inhibitors) with water and the treatment of water in heating systems and cooling systems (without inhibitors)
- Operation in potentially explosive atmospheres as defined by the ATEX Directive
- Operation with defective or missing safety devices
- Maintenance and servicing in the absence of safety devices without increased safety measures
- Operation by unqualified or insufficiently qualified personnel

2.4 Hazards during transport and installation

2.4.1 Transport

During transport and installation of the Racun 100 Advanced, hazards can occur due to heavy and tipping parts. To avoid this, observe the following safety instructions:

- Transport the Racun 100 Advanced without impact or shock.
- Use suitable means to secure the Racun 100 Advanced against tipping and falling over during transport. Do not remove any transport locks until after installation.

2.4.2 Installation

The Racun 100 Advanced may only be installed by authorised and trained specialists. Improper installation can result in personal injury. To avoid this, observe the following safety instructions:

- Wear suitable personal protective equipment during work (see section „2.6 Personal protective equipment“ on page 15).

- Do not place any heavy objects on the Racun 100 Advanced.
- Place the Racun 100 Advanced on a level surface with sufficient load-bearing capacity.
- When connecting the Racun 100 Advanced to the mains supply, ensure that the mains voltage corresponds to the specifications on the rating plate.
- Have the mains connection and earthing of the Racun 100 Advanced carried out by qualified personnel in accordance with national regulations.
- Use an all-pole switch with a distance of at least 3 mm between the contacts to connect the Racun 100 Advanced to the power supply.
- Install a high-sensitivity differential switch (0.03 A) as additional protection against electric shock.
- Route cables and hoses so that there is no risk of tripping.
- If tripping hazards cannot be avoided, mark the tripping hazards clearly.
- Carry out adjustments or simple repairs in consultation with the manufacturer.
- Do not make any changes to the Racun 100 Advanced or to the water and power supply lines.
- Position the Racun 100 Advanced so that the motor of the circulation pump is sufficiently ventilated.

2.5 Hazards during operation and maintenance

2.5.1 Mechanical hazards

The Racun 100 Advanced consists of moving or heavy components. This can result in personal injury. To avoid this, observe the following safety instructions:

- Proceed with caution when replacing heavy parts:
 - Wear suitable safety shoes
 - Secure the Racun 100 Advanced against tipping and slipping.
- Observe the relevant manufacturer's documentation when carrying out maintenance work on supplied components.
- Do not reach into rotating or moving parts of the Racun 100 Advanced with your hand during operation.

2.5.2 Hazards due to hot surfaces

Parts of the Racun 100 Advanced heat up during operation. There is a risk of burns from direct contact with hot surfaces. To avoid this, observe the following safety instructions:

- Do not touch hot pipes and the housing of the circulation pump when the appliance is switched on, but only after it has been switched-off and cooled down.
- Wear suitable protective gloves if you have to touch hot parts or work on hot parts.

2.5.3 Hazards due to electric current

The Racun 100 Advanced is powered by electricity. Touching live components can result in dangerous injuries or death. To avoid this, observe the following safety instructions:

Disconnect the main power supply before working on electrical equipment

- Disconnect the plug from the main power supply before working on electrical equipment.
- Ensure that the mains cable is fitted with an appropriate locking device for maintenance protection (lockout tagout).

Liquids

- Be careful when handling liquids. Penetrating liquids can cause short circuits or electric shocks.

Connection data

- Observe the specified electrical connection data (see section „8 Technical data“ on page 47).

Covers of the electrical components

- Do not open the covers while the Racun 100 Advanced is switched on or in operation.
- Do not remove covers even when the appliance is switched off if wiring work or checks are being carried out.

2.5.4 Dangers when handling the circulation pump

The Racun 100 Advanced utilises a circulation pump that poses various hazards. In order to avoid property damage and injury, observe the following safety instructions:

- Only use the Racun 100 Advanced in accordance with the technical data (see section „8 Technical data“ on page 47).
- Do not use the Racun 100 Advanced to transport highly flammable or hazardous liquids.
- Do not leave the Racun 100 Advanced unattended during operation or ensure that unauthorised persons do not have access to the Racun 100 Advanced.
- Switch off the Racun 100 Advanced before maintenance and repair work and disconnect the mains plug from the socket.
- Do not operate the Racun 100 Advanced with closed ball valves at the inlet and outlet of the device or the composite container.
- Check the area around the Racun 100 Advanced for leakage and remove any escaping liquids.
- Protect the pump from environmental influences such as splash water or dust.

2.5.5 Dangers due to operating fluids

The Racun 100 Advanced contains a mixed bed resin that must be replaced regularly. Skin or eye contact can cause irritation or even visual impairment. To avoid this, observe the following safety instructions:

- Observe the information in the safety data sheet.
- Wear suitable personal protective equipment when working to avoid skin and eye contact with the mixed bed resin:
 - Safety goggles
 - Protective gloves

2.6 Personal protective equipment

To work safely with the Racun 100 Advanced, you must wear various items of personal protective equipment. In the following list and at the appropriate places in the document, you will find information on the required personal protective equipment.

The following personal protective equipment is required when working with the Racun 100 Advanced:

- Protective gloves
- Safety goggles
- Protective work shoes







2.7 Warning and information signs

Places where there is a potential hazard under certain conditions are labelled with warning and information signs.

- Do not remove warning and information signs.
- Replace damaged or removed warning and information signs immediately.

The following warning and information signs are located on the Racun 100 Advanced:

Sign	Meaning	Sign	Meaning
	Warning of electrical voltage		Warning of magnetic field
	Warning of hot surface		No access for persons with pacemakers or implanted defibrillators

3

Device description

The Heaty Racun 100 Advanced filling device is a device for the initial filling of heating systems and cooling systems (without inhibitors) with water and for the permanent treatment of water in heating systems and cooling systems (without inhibitors) using the bypass method.

The Racun 100 Advanced also fulfils the following tasks:

- Make-up monitoring
- Magnetite filtering
- Sludge and fine filtering
- Conductivity monitoring
- Pressure-controlled replenishment (in conjunction with a filling combination)

The Racun 100 Advanced is intended for permanent connection to a heating or cooling system and switches off automatically when treatment is complete or the set conductivity has been reached.

The Racun 100 Advanced is intended for use in heating or cooling systems in larger residential and industrial buildings.

The following section describes the Racun 100 Advanced with its components and operating elements.

3.1 The Racun 100 Advanced at a glance

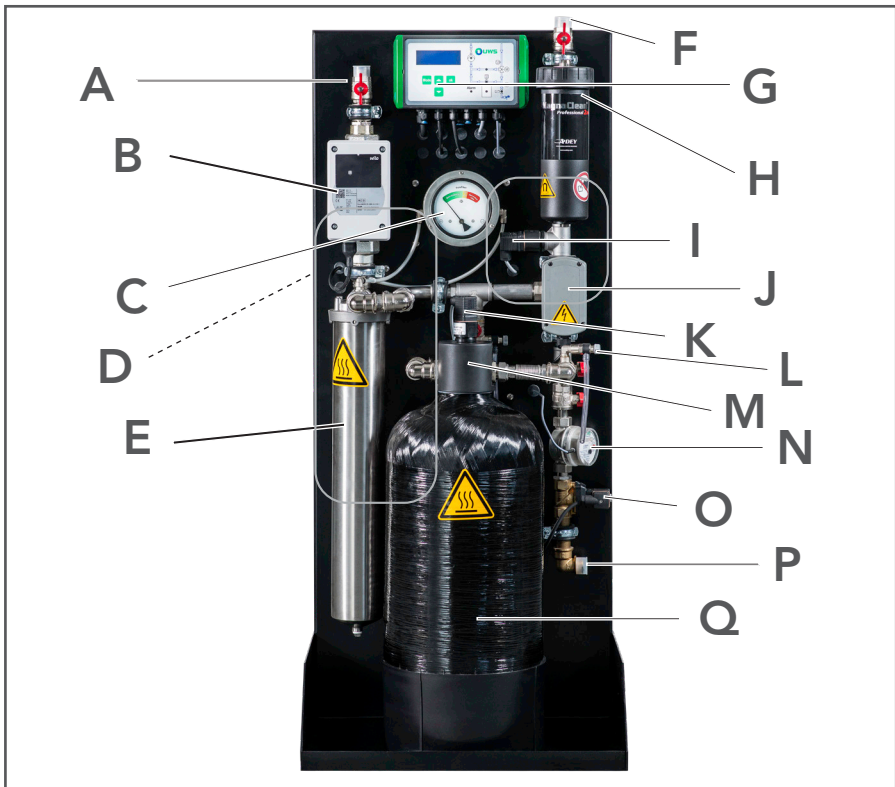

Figure 3-1: Overview of the components of Racun 100 Advanced

- | | | | |
|---|--|---|--------------------------|
| A | Circulating water outlet | I | Measuring probe LF1 |
| B | Circulation pump | J | 3-way valve |
| C | Filter capacity indicator | K | Measuring probe LF2 |
| D | Mains cable with mains plug
(concealed on the back) | L | Venting |
| E | Fine filter | M | 3-way head |
| F | Circulating water inlet | N | Water meter |
| G | Control unit | O | Solenoid valve |
| H | Magnetic flux filter | P | Replenishment connection |
| | | Q | Composite tank |

3.2 Circulating water input

The return of the heating or cooling system is connected to the circulating water input. The water from the heating or cooling system circuit is conveyed through the Racun 100 Advanced at the circulating water input.

3.3 Filter capacity indicator

The filter capacity indicator is used to detect the contamination level of the fine filter. If the contamination level of the filter is reached, the Racun 100 Advanced switches off.

3.4 Magnetic flux filter

The magnetic flux filter acts as a preliminary stage for the fine filter. It filters coarse components such as black iron oxide sludge and magnetic residues from the water. Further information on the magnetic flux filter can be found in section '9.2 Magnetic flux filter' on page 52.

3.5 Circulation pump

The circulation pump pumps the water through the Racun 100 Advanced.

3.6 Circulating water output

The return flow from the heating or cooling system is connected to the circulating water outlet. The treated water is transported from the Racun 100 Advanced into the heating or cooling system circuit via the circulating water outlet.

3.7 Control unit

You can use the control panel to access the control of the Racun 100 Advanced. Settings can be made and functions activated or deactivated in the menus of the control unit. Further information can be found in section „5.1 Making settings in the control unit“ on page 30.

The operating device continuously records system data and saves it in a log file on the SD card. The recordings can be used to analyse system faults.

The control unit has the following components:

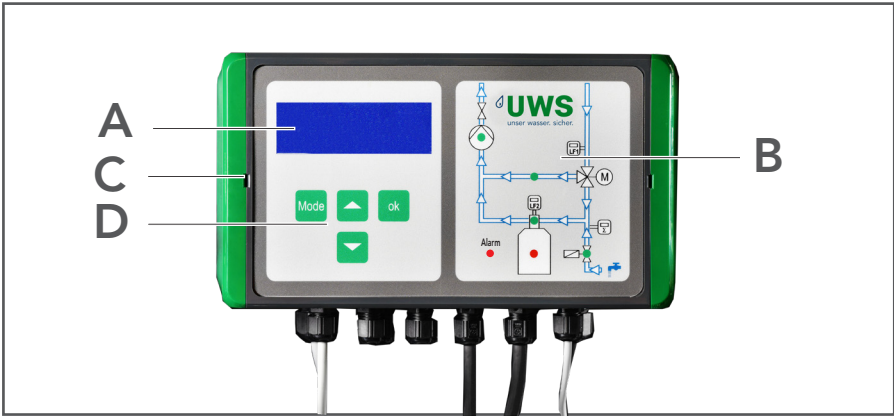

Fig. 3-3: Components of the control unit

- A Display for showing the measured values and navigation in the control menu
- B Flow chart with status display of the operating states
- C Front panel (hinged) with SD card slot (see Fig. 3-4)
- D Operating buttons

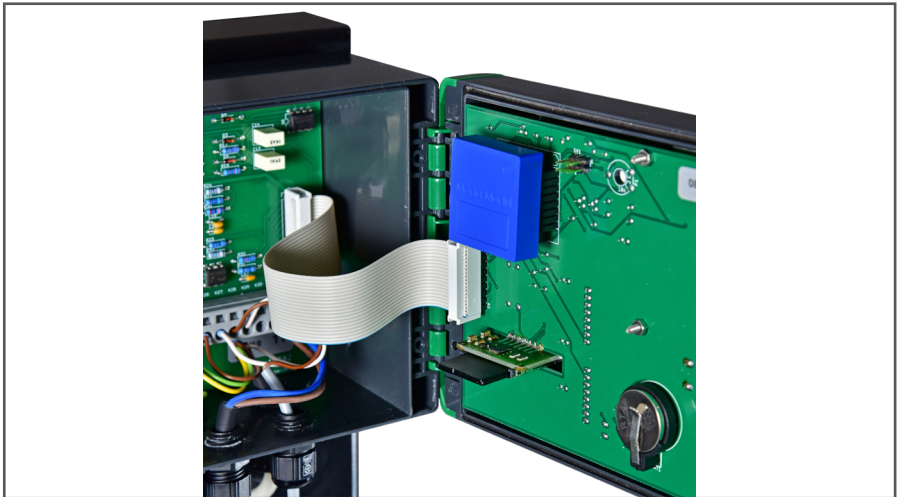

Fig. 3-4: SD card slot

Control menu

You can use the control buttons and the display to navigate through the control menu and make settings or activate functions.

The menu has the following structure:

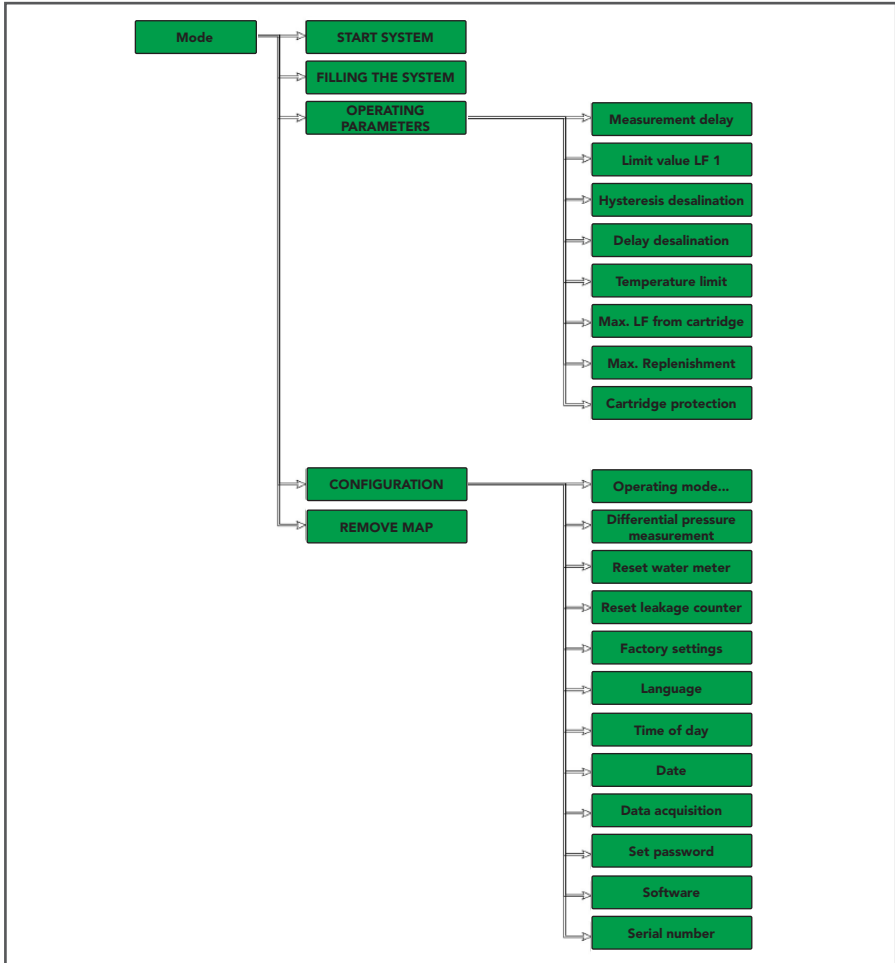

Fig. 3-5: Menu structure of the control unit

Further information on the individual functions and settings can be found in section „5.1 Making settings in the control unit“ on page 30.

Flow diagram with status display

The flow chart with status display shows the treatment process schematically. The following status displays are available at the relevant points to monitor the process:

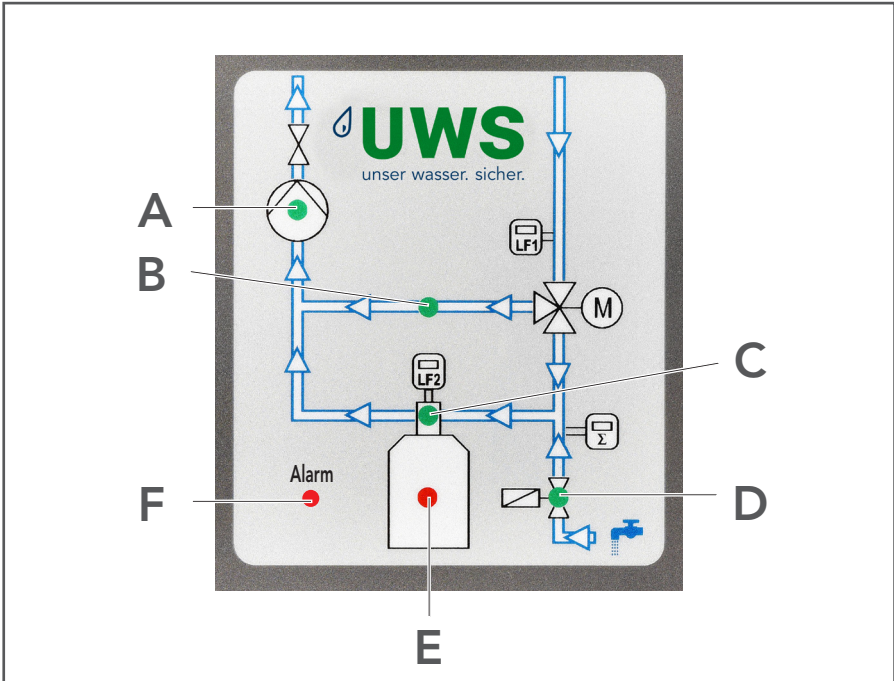

Fig. 3-6: Flow diagram with status displays

- A „Pump on“ indicator light
- B „Internal bypass active“ indicator light
- C „Treatment active“ indicator light
- D „Solenoid valve backfeed“ indicator light
- E „Cartridge used“ indicator light
- F „Alarm“ indicator light (cartridge used up, LF1/LF2 measuring probe fault, filter full, pump fault)

3.8 Cartridge

Water treatment takes place in the mixed bed resin of the cartridge by ion exchange until the capacity of the mixed bed resin is exhausted. The cartridge can be rinsed automatically at regular intervals to prevent the cartridge from becoming contaminated (see 'Cartridge protection' function in section '5.1.3 Operating parameters' on page 30).

3.9 Fine filter

The fine filter works together with the magnetic flux filter. It cleans the water pre-filtered by the magnetic flux filter of very small and suspended particles up to a size of 1 µm.

The fine filter is structured as follows:

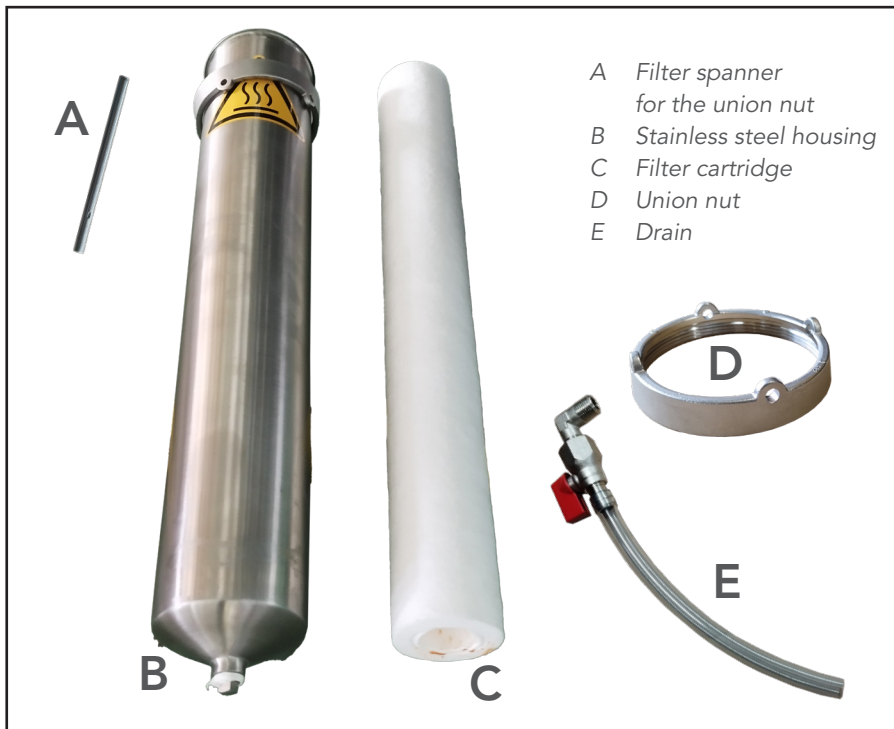

Fig. 3-7: The fine filter in dismantled condition

3.10 Changeover value

The changeover value is an electromotor-driven ball valve that switches the internal bypass depending on the conductivity. If the measuring probe LF1 detects a deviation from the set conductivity, the water is channelled through the cartridge. When the set conductivity is reached, the changeover value switches and the water only flows through the magnetic flux filter.

3.11 Cartridge output filter

The cartridge outlet filter is used to prevent damage to the suction lance and head nozzle in the cartridge to prevent resin leakage.

3.12 Solenoid valve

The solenoid valve is closed when de-energised and switches off the drinking water supply during pressure-controlled replenishment if the set limit value for maximum replenishment is exceeded.

3.13 Filling/backfeed connection

The drinking water pipe is connected to the filling/backfeed connection in order to fill a heating or cooling system.

4

Transport, installation and commissioning

4.1 Transport

Use lifting equipment such as a crane or forklift truck to transport the Racun 100 Advanced. The lifting equipment must be suitable, tested and authorised.

Observe the following instructions during transport:

- Use suitable aids to secure the Racun 100 Advanced against slipping and tipping over.
- Only load the Racun 100 Advanced at suitable points during transport.
- Remove the transport devices after transport.

4.2 Installation and commissioning

To prevent damage to the Racun 100 Advanced or injury to persons, observe the following instructions during installation and commissioning:

- Installation and commissioning may only be carried out by trained specialists from a recognised specialist company in the HVAC sector, taking into account the necessary safety measures.
- Before starting installation, check the Racun 100 Advanced for completeness and possible transport damage. The following components are included in the scope of delivery:
 - Racun 100 Advanced as ordered, pre-assembled
 - Operating instructions
 - Maintenance key Magnetic flux filter
- Place the Racun 100 Advanced on a firm and level surface.
- Do not install the Racun 100 Advanced in areas at risk of frost.
- When selecting the installation location, ensure that there is sufficient space to carry out maintenance work (e.g. changing the mixed bed resin, cleaning the magnetic flux filter).
- Lay cables and pipework in such a way that there is no risk of tripping. Mark unavoidable tripping hazards.
- Connect the Racun 100 Advanced to the power supply correctly and observe the electrical connection data (see section „8 Technical data“ on page 47).

- If a connection to the building management system is planned, this work must be carried out by a qualified electrician. Observe the terminal diagram (see section „9.4 Control terminal diagram“ on page 57).

The Racun 100 Advanced is intended for fixed installation in a heating or cooling system.

Observe the following instructions during installation:

- Before installing the Racun 100 Advanced, familiarise yourself with the specific structure of the heating or cooling system. Contact the manufacturer if you require support.
- Select the points for integrating the Racun 100 Advanced into the return of the heating or cooling system so that they are far enough apart. A short circuit must be avoided.
- Install a 3/4" connection piece at each of the points in the return of the heating or cooling system.
- Lay pipelines from the connection pieces to the circulating water inlet and to the circulating water outlet of the Racun 100 Advanced:



- Connect the filling/replenishment connection to the drinking water pipe. Use the screen seal supplied to prevent malfunctions of the changeover valve:

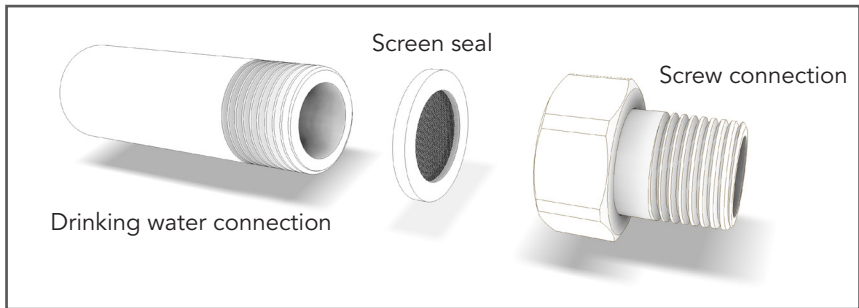

- When connecting to the drinking water pipe, use a filling combination from the manufacturer (see section „6.4 Spare parts and accessories“ on page 43).
- The drinking water must not exceed a temperature of 25° C and must be free of suspended matter. Connect an appropriate filter system upstream if necessary.
- The drinking water pipe must have a flow pressure of at least 1.5 bar when filling heating or cooling systems. The filling combination causes a pressure loss of approx. 1 bar. Use a suitable pressure booster system if the system pressure must be higher than the flow pressure of the drinking water pipe.
- Ensure that the installation work is carried out professionally and that the result complies with the relevant regulations and provisions.

The following figure shows an example of connecting the Racun 100 Advanced using the bypass method:

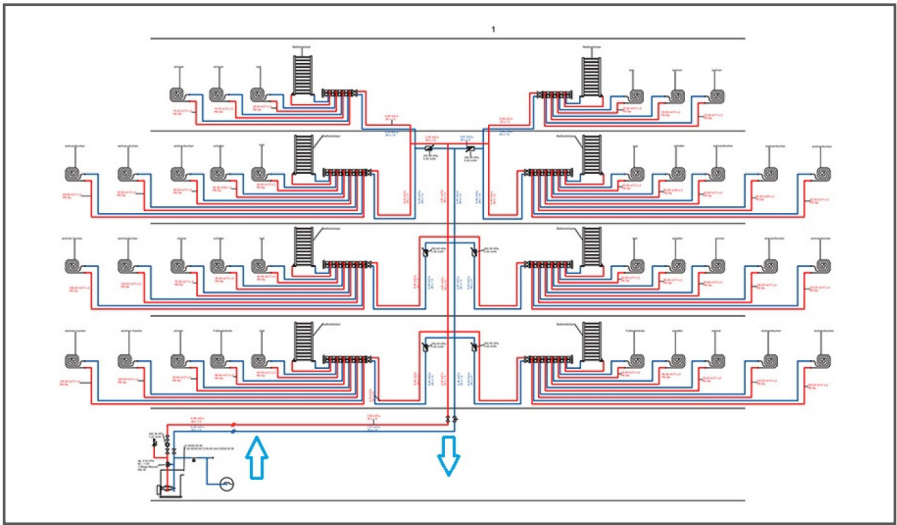

Figure 4-8: Connection diagram bypass method

5

Operation

The following section contains information on operating the Racun 100 Advanced.



NOTE

Operating elements

The operating elements referred to in the text are explained in section „3 Device description“ on page 17.

5.1 Making settings in the control unit

The control unit (see „3.7 Control unit“ on page 20) gives you access to the control of the Racun 100 Advanced. You can make the following settings and activate or deactivate functions in the control menu:

5.1.1 Start system

The **Start system** function is used to start or stop the Racun 100 Advanced regardless of the operating mode.

5.1.2 Anlage befüllen

The **Fill system** function is used to define which of the two filling parameters leads to the automatic switch-off of the Racun 100 Advanced when reached. The following filling parameters are available for selection:

- Volume of the heating or cooling system (filling quantity in litres)
- Duration of filling (time in minutes)

5.1.3 Operating parameters

Measurement delay

The **measurement delay** function is used to set the measurement delay for long connection lines between Racun 100 Advanced and the heating or cooling system. With this function, water quantities in a long line are taken into account by the device.

Limit value LF1

The **limit value LF1** function is used to specify the limit value for the conductivity in the range of 30-500 μS .

Desalination hysteresis

The **desalination hysteresis** function is used to set the tolerance for the limit value LF1 in the range of 1-95 μS in order to prevent the treatment from constantly starting and stopping.

Example: With a set limit value LF1 of 100 μS and a hysteresis of 20 μS , the treatment is only reactivated from a conductivity of 120 μS or deactivated from 80 μS .

Desalination delay

The **desalination delay** depends on the size of the cartridge and is preset by the manufacturer.

Temperature limit value

The **Temperature limit function** is used to specify a limit value for the water temperature (max. 80° C), at which the Racun 100 Advanced is switched-off.

Maximum conductivity from cartridge

The **Maximum conductivity from cartridge** function can be used to set a limit value for the consumption of the cartridge and thus control the treatment.

Recommendation: Factory setting of 60 μS

Maximum replenishment

The **Maximum replenishment** function is used to specify a limit value for replenishment in litres/week. Exceeding this limit value can indicate a pipe break, leakage or similar and leads to the replenishment being shut off by the solenoid valve. Exceeding the limit value is signalled by an alarm on the flow diagram with status display (see section „3.7 Control unit“ on page 20) and, if necessary, transmitted to the building management system.

Cartridge protection

The **cartridge protection** function is used to activate or deactivate the automatic flushing of the cartridge and to set the interval for automatic flushing (1-30 days).

5.1.4 Configuration

Operating mode

The **operating mode** function can be used to select between the operating modes continuous operation, normal operation and filtration.

Filter capacity indicator

The **Filter capacity indicator** function can be used to switch the filter capacity indicator for the contamination level of the fine filter and the pump motor protection switch fault on or off.

Reset water meter

The **Reset water meter** function is used to reset the internal water meter in order to start a new measurement..

Delete leakage times

The **Delete leakage times** function is used to reset the counter for the maximum replenishment in order to start a new measurement.

Factory settings

The **Factory settings** function restores the factory settings. All manual settings are lost.

Language

The **Language function** is used to select the language of the user interface between English EN and German DE.

Time

The **Time** function can be used to set the time.

Date

The **Date** function can be used to set the date.

Data recording

The **Data recording** function can be used to set the interval at which data is written to the log file on the SD card..

Set password

The **Set password** function can be used to set or change a password that is used to secure settings.



NOTE

Delivery status

On delivery, the settings of the Racun 100 Advanced are not secured with a password.

Software

The **Software** function is used to display the software version.

Serial number

The **Serial number** function displays the serial number of the control unit.

5.1.5 Remove card

The **Remove card** function can be used to disconnect the SD card from the operating device in order to remove it and read out the log file.

To remove the card, proceed as follows:

- 1 Execute the **Remove card** function in the menu of the operating device.
→ The SD card is disconnected from the control unit.
 - 2 Switch off the Racun 100 Advanced as described in section „5.4 Switching off the Racun 100 Advanced“ on page 37.
-



DANGER

Danger of electric shock

The operating device is live. Only open the control unit when it is de-energised.

- 3 Pull the mains plug out of the socket.
 - 4 Open the front panel of the control panel and remove the SD card from the slot.
→ The SD card can be read out.
-



NOTE

Inserting the SD card

To reinsert the SD card after reading it out, insert the SD card back into the slot and close the front panel of the operating device.

5.2 Racun 100 Advanced operate

To operate the Racun 100 Advanced, proceed as follows:



CAUTION

Checking the heating or cooling system before initial filling

Before filling a heating or cooling system with Racun 100 Advanced for the first time, observe the following instructions:

- Flush and clean the heating or cooling system in accordance with EN 14336 and record the flushing and cleaning.
 - Measure the conductivity and water hardness of the raw water and enter the values in the system log.
 - If the raw water is softened, measure the conductivity and use the conversion tables to estimate the capacity of the Racun 100 Advanced (see section „9 Other applicable documents“ on page 49).
 - Please note that the use of a water softener can lead to increased conductivity of the drinking water.
 - Ensure that the drinking water pipe has a flow pressure of at least 1.5 bar when filling heating or cooling systems. If the pressure falls below this value, the capacity of the Racun 100 Advanced may be impaired.
 - The drinking water must be free of suspended matter. If necessary, connect an appropriate filter system upstream.
 - Observe the instructions for reducing conductivity during operation.
 - Ensure that a filling combination is installed on the Racun 100 Advanced before the filling/replenishment connection. Observe the regulations of the responsible water supply companies.
 - The use of a filling combination can lead to a pressure loss of approx. 1 bar. Use a suitable pressure booster system if the system pressure must be higher than the flow pressure of the drinking water pipe.
-

Prerequisites

- The Racun 100 Advanced is installed correctly as described in section „4.2 Installation and commissioning“ on page 26.
- The SD card is inserted in the control unit if system data is to be recorded.
- The fine filter and the magnetic flux filter have been checked and replaced or cleaned if necessary (see section „6 Maintenance and servicing“ on page 38).

Procedure

- 1 Open the drinking water pipe to which the **filling/replenishment** connection is connected.



NOTE

The volume flow through the Racun 100 Advanced is limited by the integrated flow limiter. You can fully open the drinking water pipe.

- 2 Insert the mains plug into the socket.



NOTE

When connecting, observe the electrical connection data (see section „8 Technical data“ on page 47).

- 3 Use the control unit to make the desired settings on the control unit:
 - Select the operating mode (continuous or normal operation - **operating mode** function)
 - Set the filling parameters (**Fill system** function)
 - Specify the desired conductivity (**Limit value LF1** function)

Adjust other operating parameters if necessary.



NOTE

Selecting the operating mode

You can choose between the following operating modes under the **Operating mode** function:

- Normal operation: Treatment pauses when the set limit value is reached, after 2 hours of constant conductivity the Racun 100 Advanced goes into standby mode
 - Continuous operation: Continuous treatment (suitable for heating or cooling systems heavily contaminated with magnetite or wet sludge)
 - Filtration: Pure filtration of magnetite and particles up to 1 µm
-

- 4 Make sure that the system temperature of the heating or cooling system is system is a maximum of 80 °C.
- 5 Ensure that the **circulation pump vent** is closed.
- 6 Open the fittings on the connections of the heating or cooling system. system.
 - ➔ A partial volume flow of the heating or cooling system flows via the Racun 100 Advanced.
- 7 Use the **Start/Stop** function on the control panel to start the Racun 100 Advanced.
 - ➔ The Racun 100 Advanced begins treatment of the circuit water.

The circulating water flows through the Racun 100 Advanced and is channelled through the cartridge as required. The following measurements are used for this purpose:

- Measuring probe LF1: Measurement of the conductivity before treatment in the bypass
- Measuring probe LF2: Measurement of the conductivity after the cartridge to monitor the capacity

Function of the Racun 100 Advanced in normal operation

If the conductivity before treatment (measuring probe LF1) is too high, the changeover value switches to bypass to the cartridge. When the set conductivity limit value is reached, the changeover value switches to internal bypass. The water no longer flows through the cartridge. The conductivity is continuously measured by the measuring probe LF1. In the event of deviations, the changeover value switches back to flow to the cartridge until the set conductivity limit value is reached.

If the conductivity remains constant for a period of 2 hours, the Racun 100 Advanced is switched to standby mode.

During standby mode, the Racun 100 Advanced checks the conductivity daily at an adjustable wake-up time. If there are deviations, treatment is restarted.

With pressure-controlled replenishment, the Racun 100 Advanced records the amount of water backfeed and stops replenishment when the maximum replenishment level is reached.

5.3 Switching off the Racun 100 Advanced in an emergency

To switch off the Racun 100 Advanced in an emergency, proceed as follows:

- 1 Pull the mains plug out of the socket.
 - ▶ The Racun 100 Advanced is switched off.
- 2 Eliminate all causes that led to the Racun 100 Advanced being switched off.

To switch the Racun 100 Advanced on again after an emergency, proceed as described in section '5.2 Operating the Racun 100 Advanced' on page 34.

5.4 Switching off the Racun 100 Advanced

To switch off the Racun 100 Advanced after treatment is complete, proceed as follows:

- 1 Use the **Start/Stop** function of the control unit to stop the Racun 100 Advanced.
- 2 Pull the mains plug out of the socket.
- 3 Allow the Racun 100 Advanced to cool down.
- 4 Close the fittings on the heating or cooling system so that no more partial volume flow runs through the Racun 100 Advanced.
 - ➔ The Racun 100 Advanced is switched off.



Maintenance and servicing

To ensure trouble-free operation of the Racun 100 Advanced, the device must be kept in a clean and functional condition. Furthermore, regular visual and functional checks must be carried out in order to recognise and rectify any damage at an early stage.



WARNING

Risk of injury due to improperly performed maintenance work

The Racun 100 Advanced may only be serviced by specialised personnel trained in safety technology.

Carry out the following steps before carrying out any maintenance and servicing work:

- Switch off the Racun 100 Advanced.
 - Disconnect the Racun 100 Advanced from the power supply.
 - Take suitable measures to prevent the Racun 100 Advanced from being switched on again.
 - Also observe the safety instructions in section „2 Safety instructions“ on page 10.
-

6.1 Maintenance schedule



NOTE

Deviating intervals in continuous operation

If the Racun 100 Advanced is operated in continuous operation, shorter maintenance intervals may be necessary. Coordinate the intervals with a specialist, taking into account the operating conditions.

The following table contains an overview of the maintenance work to be carried out regularly:

Interval	Activity	Responsibility
Before installation in a heating or cooling system	Check the fine filter and magnetic flux filter and replace depending on the contamination level (Change the fine filter after 100 m ³ at the latest)	Operating personnel
	Check suction lance nozzles for damage and blockages and clean or replace if necessary	Operating personnel
	Check the flow limiter for blockages	Operating personnel
Monthly	Check pipelines for leakage and replace if necessary	Operating personnel
Half-yearly	Check the fastening and position of the Racun 100 Advanced as well as welded and screw connections	Operating personnel
Annually	Check warnings and labelling on the Racun 100 Advanced	Operating personnel
	Clean measuring probes LF 1 and LF 2	Operating personnel
	Replace filter	Operating personnel

6.2 Maintenance work

6.2.1 Changing the mixed bed resin



NOTE

Carrying out the change

For the Heaty Racun 100 Advanced appliance type, it is recommended that the mixed bed resin is changed by the manufacturer's service personnel. Cartridge hire from the manufacturer, including delivery and collection service, is available on request.



NOTE

Handling mixed bed resin

Observe the following points when handling the mixed bed resin:

- Do not store the mixed bed resin open, otherwise it will lose its capacity.
 - Use the outer packaging of the refill pack to dispose of the replaced mixed bed resin.
 - Replace the mixed bed resin over a drain so that the water separated from the replaced mixed bed resin can drain away.
 - Wear suitable personal protective equipment (safety goggles, gloves).
-

Proceed as follows to change the mixed bed resin in the composite container when the LED display signals this:

- 1 Make sure that the Racun 100 Advanced is **switched off** and disconnected from the **disconnected from the power supply**.
- 2 Close the **cartridge stopcock** on the left and right of the cartridge.
- 3 Open the **cartridge drain** on the left and right of the cartridge to vent the cartridge.
- 4 Open the **union nuts** and remove the cartridge.

- 5 Turn the head anti-clockwise to release the head.



- 6 Pull the head with the suction lance out of the cartridge.



- 7 Remove the refill pack with mixed bed resin from the outer packaging and place the outer packaging in a sufficiently large container.
- 8 Empty the exhausted mixed bed resin from the composite container into the container with the outer packaging:
- ▶ The mixed bed resin is retained by the outer packaging and the water collects in the container.
- 9 Dispose of the mixed bed resin and empty the water into a drain.

- 10 Open the mixed bed resin refill pack and fill it into the cartridge using a funnel. If necessary, compact the mixed bed resin by shaking or circling the cartridge.
- 11 Fill the cartridge with water to a height of approx. 2 cm below the thread.
- 12 Stir the mixed bed resin with a pipe or other suitable tool to make it easier to insert the head with suction lance.
- 13 Insert the head with suction lance back into the cartridge.
- 14 Tighten the head clockwise by hand.
 - ➔ The mixed bed resin has been changed and the cartridge is working at full capacity again.

6.2.2 Cleaning the magnetic flux filter

Information on cleaning the magnetic flux filter can be found in section '9.2 Magnetic flux filter' on page 54.

6.2.3 Changing the fine filter

To change the fine filter, proceed as follows:



NOTE

The fine filter must be checked and replaced if necessary before the Racun 100 Advanced is installed in a heating or cooling system.

The fine filter must be replaced at the latest after the treatment of 100 m³ of water.

- 1 Make sure that the Racun 100 Advanced is switched off and has been disconnected from the heating or cooling system.
- 2 Make sure that the shut-off valves at the **circulating water inlet** and the **circulating water outlet** are closed.
- 3 Open the drain at the bottom of the fine filter housing and drain the excess pressure into a suitable container.



- 4 Open the fine filter using the supplied filter spanner for the union nut and remove the filter cartridge.
- 5 Clean the stainless steel housing of the fine filter.
- 6 Close the fine filter drain when there is no more water in the fine filter.
- 7 Insert a new filter cartridge.
- 8 Close the fine filter again using the filter key.
 - ➔ The fine filter has been replaced.
The Racun 100 Advanced is ready for operation again.

6.3 Regular internal inspection

Certain parts of the Racun 100 Advanced are additionally checked and serviced at regular intervals:

- Circulation pump and motor protection switch
- Measuring probes LF 1 and LF 2
- Output filter cartridge

The inspection dates must be coordinated by the operator.

6.4 Spare parts and accessories

The following spare parts are available from the manufacturer for the Racun 100 Advanced:

Art.no.	Description
100041	Funnel
100047-1	Measuring case „PROFI“
100055	Refill pack 23 litres of mixed bed resin (Vadion pH Control, for Racun 100 Advanced only 1 pack required for complete refill)
300900	UWS filling combination 1/2" incl. system separator (optional)
101016	Composite container Heaty 100 without head / empty hot water
100488-1	Filter cartridge 1µm
100463	Measuring probe for UWS Heaty Racun 100 + 300
100463-1	Solenoid valve set UWS Heaty Racun 100 + 300
100471-1	3-way head UWS Heaty Racun 100
100012-10	Seal 3-way head
100464	Pump for UWS Heaty Racun 100 + 300
FL-03-01690	Magna Clean Professional 2xp 1"



NOTE

Service from the manufacturer

The components are usually permanently connected to the Racun 100 Advanced and must not be replaced by the customer. The manufacturer's customer service department must be contacted in the event of faults or malfunctions.

7

Dismantling and disposal**CAUTION**

The Racun 100 Advanced may only be dismantled by authorised and qualified personnel who are familiar with the dangers.

**NOTE****Regulations and laws**

Observe the local regulations and laws on the disposal of environmentally harmful substances.

- The Racun 100 Advanced may only be dismantled by authorised specialist personnel.
- Observe the safety instructions in the operating instructions in section „2 Safety instructions“ on page 10.
- Do not touch any live components.
- Wear suitable personal protective equipment.
- Only use suitable and tested lifting equipment.

Injuries can be caused by

- Live components
- Heavy components that fall down after being released
- Sharp edges

7.1 Specialised personnel

Specialist personnel must observe the following points:

- Observe the safety instructions in this operating manual.
- Wear suitable personal protective equipment.
- Only use suitable and tested lifting equipment.
- Use suitable means of transport and keep the transport routes clear.
- Switch off the Racun 100 Advanced before starting work and disconnect it from the power supply.

7.2 Disassembly

To dismantle the Racun 100 Advanced, proceed as follows:

- 1 Switch off the Racun 100 Advanced and disconnect the power supply from the mains as described in section „5.4 Switching off the Racun 100 Advanced“ on page 37.
- 2 Discharge energy storage devices such as springs or capacitors, if present.
- 3 Ensure that any residual pressures have been released. To do this, open the drain valves.
- 4 Disconnect the pipelines of the Racun 100 Advanced from the heating or cooling system.
- 5 Empty the residual quantities into a drain.
- 6 If you want to store the Racun 100 Advanced or take it out of operation, drain the Racun 100 Advanced completely.
- 7 If you want to dispose of the Racun 100 Advanced, disassemble the Racun 100 Advanced into its components using suitable tools.

7.3 Disposal

Dispose of assemblies and operating materials in a professional and environmentally friendly manner.

Observe the legal and operational regulations.



Technical data

In this section you will find technical data on the Racun 100 Advanced in general as well as on the applications and components used.

8.1 General data

Heaty Racun 100 Advanced	
Item number	100488-SL
Height × width × depth (approx.)	1.230 x 520 x 410 mm
Weight (without mixed bed resin)	approx. 47 kg
Recommended system size	bis 40 m ³
Mains connection	230 V - 50/60 Hz
Maximum operating pressure	6 bar
Maximum operating temperature	80° C
Flow pressure drinking water pipe	1,5-6 bar
Maximum filling capacity for direct filling	1.200 l/h
Average treatment in bypass process	approx. 750 l/h
Capacity of composite tank	23 l
Capacity at 420 µS/cm to <100	3.420 l
Average filtration in the bypass process	approx. 2,000 l/h

8.2 Components

8.2.1 Magnetic flux filter

Manufacturer	ADEY Professional Heating Solutions, Cheltenham (UK)
Type	MagnaClean® Professional2XP
Maximum flow rate	80 l/min
Capacity (approx.)	500 g
Maximum operating pressure	6 bar
Maximum operating temperature	80 °C

Further information on the magnetic flux filter can be found in section „9.2 Magnetic flux filter“ on page 52.

8.2.2 Circulation pump

Maximum operating pressure	10 bar
Ambient temperature	-20 °C to 110 °C
Maximum media temperature	95 °C



Applicable documents

These operating instructions apply together with the following documents:

- Safety data sheet Vadion pH-Control
- Capacity calculator for filling devices, see UWS app or homepage of the manufacturer: <https://uws-technologie.de/berechnungstools/>
- Measured values and conversion tables, see „9.1 Measured values and conversion tables“ on page 49
- Information on the magnetic flux filter, see „9.2 Magnetic flux filter“ on page 52
- Quick guide to the changeover value, see „9.3 Quick guide to the changeover value“ on page 55
- Control terminal diagram, see „9.4 Control terminal diagram“ on page 57
- Terminal diagram for measuring probes, see „9.5 Terminal diagram for measuring probes LF1/LF2“ on page 57

9.1 Measured values and conversion tables

9.1.1 Corrosion rate

Oxygen, acids and dissolved salts cause corrosion in the heating or cooling system. The speed of corrosion depends on the amount of substances dissolved in the water, which can be assessed by measuring the conductivity.

The following reference values apply for estimating the corrosion rate with the help of conductivity:

Conductivity [$\mu\text{S}/\text{cm}$]	Corrosion rate
0–100	braked
100–350	very slow
350–500	slow
500–1,000	accelerated
1,000–2,000	strongly accelerated
>2,000	very strongly accelerated

9.1.2 Lime content and water hardness

The lime content and water hardness can be roughly estimated by measuring the conductivity. The following table illustrates the relationships:

Conductivity [$\mu\text{S}/\text{cm}$]	Lime content [g/1,000 litres]	Classification Water hardness
<100	<35	desalinated
100	50	very soft
200–300	100-150	soft
400–500	200-250	medium hard
600–800	300-400	hard
900–1,000	450-500	very hard

The following table is used to determine the exact water hardness:



NOTE

This conversion is only applicable if the water is not softened and does not contain any chemical additives.

If the water is softened, it must be measured using the hardness drop method. Hand-held measuring devices do not provide meaningful values for softened water.

Conduc-tivity [μS/cm]	Hard-ness [°dH]	Hard-ness [°fH]	Lime content [g/1.000 l]	Conduc-tivity [μS/cm]	Hard-ness [°dH]	Hard-ness [°fH]	Lime content [g/1.000 l]
<100	<1	<2	<35	1,120	32	57	560
105	2	5	53	1,155	33	59	578
140	4	7	70	1,190	34	61	595
175	5	9	88	1,225	35	62	613
210	6	11	105	1,260	36	64	630
245	7	12	123	1,295	37	66	648
280	8	14	140	1,330	38	68	665
315	9	16	158	1,365	39	69	683
350	10	18	175	1,400	40	71	700
385	11	20	193	1,435	41	73	718
420	12	21	210	1,470	42	75	735
455	13	23	228	1,505	43	77	753
490	14	25	245	1,540	44	78	770
525	15	27	263	1,575	45	80	788
560	16	28	280	1,610	46	82	805
595	17	30	298	1,645	47	84	823
630	18	32	315	1,680	48	85	840
665	19	34	333	1,715	49	87	858
700	20	36	350	1,750	50	89	875
735	21	37	368	1,785	51	91	893
770	22	39	385	1,820	52	93	910
805	23	41	403	1,855	53	94	928
840	24	43	420	1,890	54	96	945
875	25	45	438	1,925	55	98	963
910	26	46	455	1,960	56	100	980
945	27	48	473	1,995	57	101	998
980	28	50	490	2,030	58	103	1,015
1,015	29	52	508	2,065	59	105	1,033
1,050	30	53	525	2,100	60	107	1,050
1,085	31	55	543	2,100	60	107	1,050

9.2 Magnetic flux filter

This section contains illustrations and the characteristic curve of the built-in magnetic flux filter.

9.2.1 Drawings

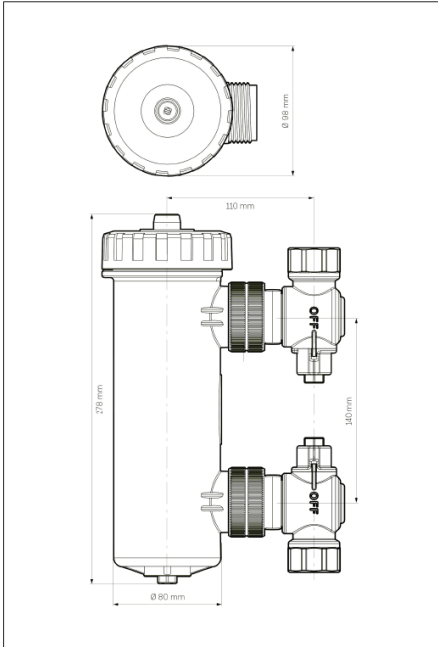

Fig. 9-9: View of magnetic flux filter with inlet and drain valve

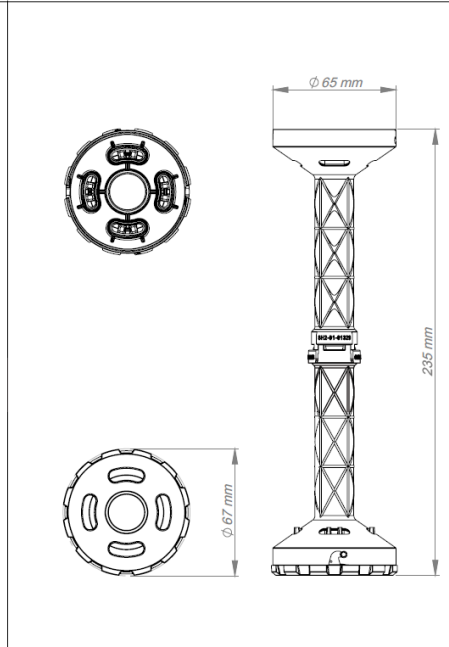

Fig. 9-10: View of inner part of magnetic flux filter

9.2.2 Characteristic curve

The flow resistance diagram of the magnetic flux filter shows the following characteristic curve:

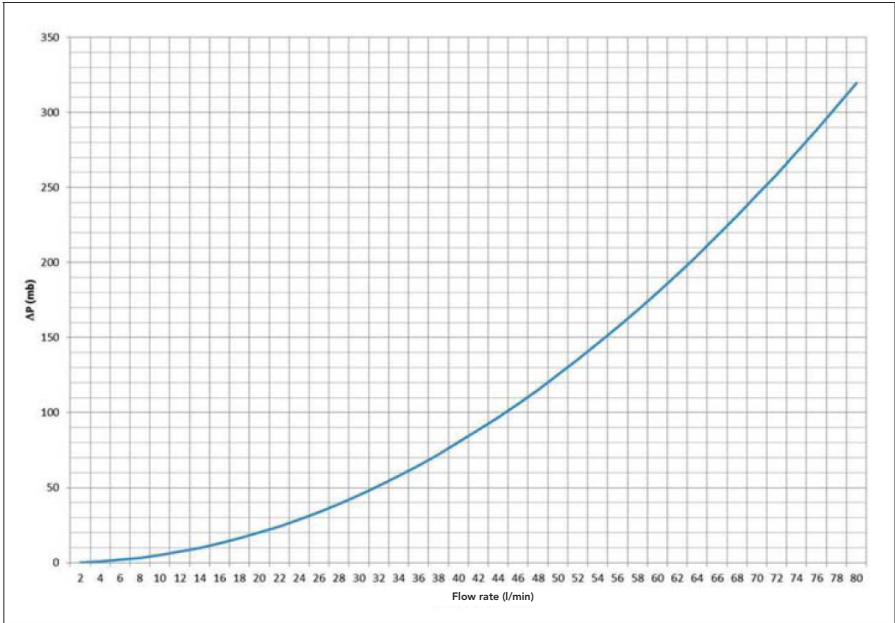
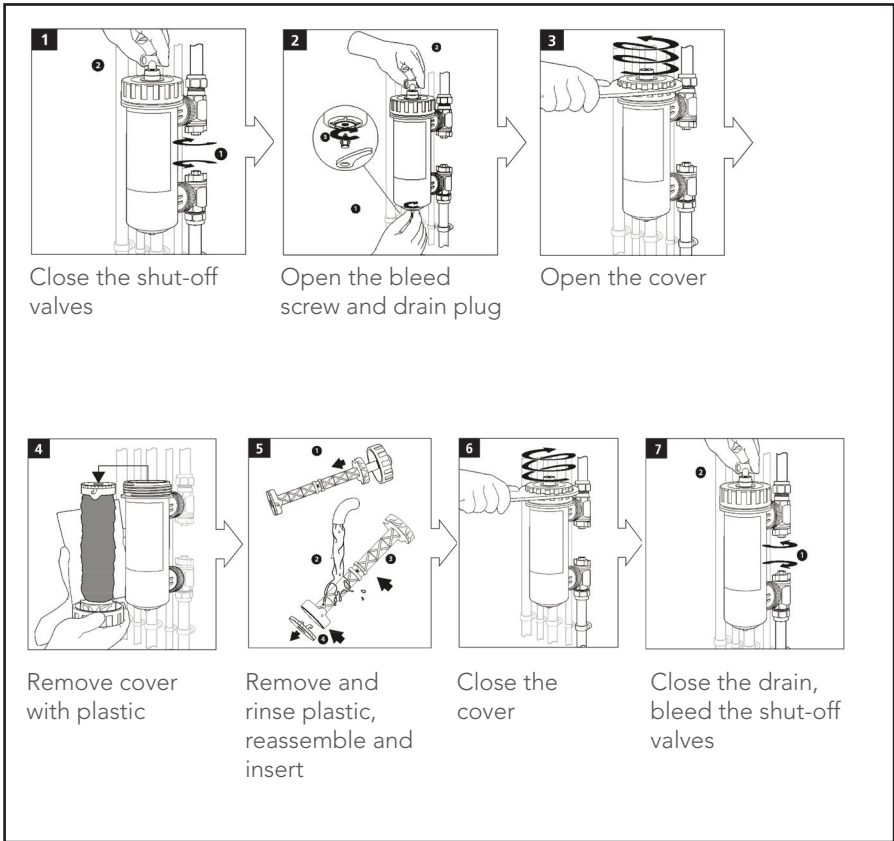

Fig.9-11: Magnetic flux filter characteristic curve

9.2.3 Cleaning

To clean the magnetic flux filter, proceed as follows:



9.3 Quick guide to the changeover value

GB ELECTRIC MOTOR ACTUATED BALL VALVE
D KUGELHAHN MIT ELEKTROMOTORISCHEM ANTRIEB
 EMV 110...
 SERIES 930



INSTALLATION INSTRUCTION AND USER'S MANUAL
 MONTAGEANWEISUNG UND BEDIENUNGSANLEITUNG

Installation should be carried out only by a qualified person!
 Die Montage darf nur vom Fachmann ausgeführt werden!

DIMENSIONS / ABMESSUNGEN

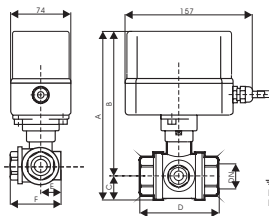

DIMENSIONS / ABMESSUNGEN								
G	DN	A	B	C	D	E	F	KV
1 1/2"	32	226	193	33	130	64	100	20
1 1/2"	40	239	200	39	150	70	116	37,2
2"	50	254	207	47	170	90	135	48,7

*EMV 110 930/310 with relay / mit Relais			
TYP / TIP	CODE	G	DN
930/410	10025	1 1/2"	32
930/410	10026	1 1/2"	40
930/410	10027	2"	50

ELECTRICAL CONNECTION / ELEKTRISCHER ANSCHLUSS

EMV 110..410 (230VAC)
 EMV 110..413 (24VAC)

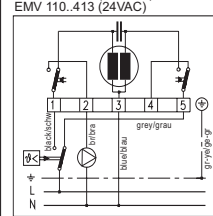

*EMV 110 930/310 with relay / mit Relais

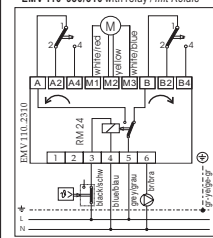

BUILD-IN ROOM / EINBAURAUM

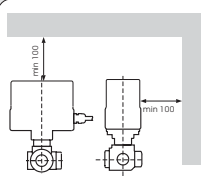

TECHNICAL DATA / TECHNISCHE DATEN

Mains connection / Nennspannung: 230 V~, 50Hz
 * 24 V~, 50Hz

Power consumption / Nennleistung: 3,5 W max

Rotation time / Rotationszeit: 105s / 90°

Microswitch rating / Belastung der Mikroschalter: 5(1)A, 250 VAC

Actuator protection class / Antriebsschutzart: IP 54

Terminals / Anschlussklemmen: 0,5 ... 1 mm²

Cable length / Kabellänge: 1500 mm

Ambient temperature / Umgebungstemperatur: 0 ... 50°C

Fluid temperature / Temperatur des Fluids: 0 ... 110°C max

Output torque / Ausgangsmoment: 25 Nm

Fluids and gasses (water, nonaggressive media) up to 1 bar.
 Flüssige und gasförmige Medien (Wasser, nicht aggressive Fluide) bis zu 1 bar

HYDRAULIC INSTALLATION - RECOMMENDED INSTALLATION OF THE ELECTRIC ACTUATED BALL VALVE
 SCHEMA DER MASCHINENINSTALLATION EMPFOHLENER EINBAU DES KUGELVENTILS MIT ELEKTROMOTORANTRIEB

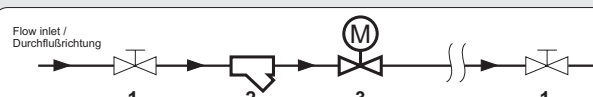

- 1 manual stop valve / Manuelle Absperrvorrichtung
- 2 strainer with the mesh width 0,65 mm / Reinigungsfilter Y (für detaillierte Informationen bitte rufen Sie uns an lieferbar in Abmessungen von 1 1/2" bis 2")
- 3 motor actuated ball valve series EMV 110... Elektromotorantrieb mit Kugelventil EMV 110...

IMPORTANT !
 To extend the long term performance of the motorised ball valve it is recommended that a strainer is situated prior to the valve. By installation must be observed to according to relevant local standards.

WICHTIG!
 Um die Lebensdauer des Ventils zu erhöhen und Beschädigung der Dichtungen durch mechanische Teile in der Installation zu verhindern, wird der Einbau eines Reinigungsfilters empfohlen. Die einschlägigen VDE+TUV-Vorschriften sind zu beachten.

BUILD-IN POSITION / EINBAULAGE

PRIORITY / VORRANGIGE EINBAULAGE

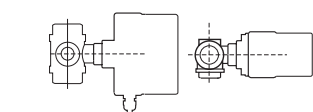

ALLOWED / MÖGLICHE LAGE

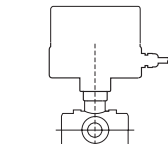

NOT ALLOWED ! UNERLAUBTE LAGE !

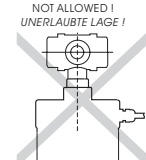

Fig. 9-12: Quick guide to changeover value, page 1

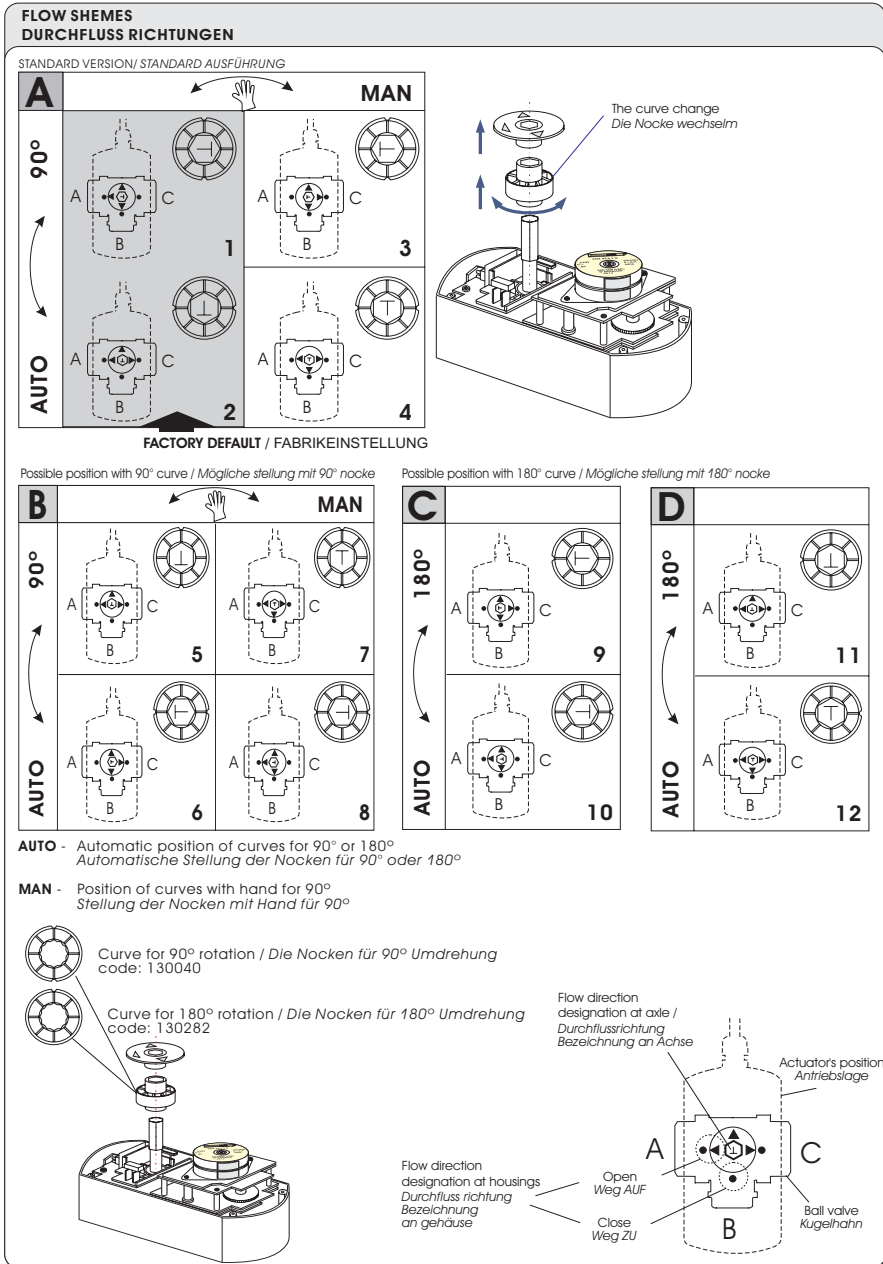

Fig. 9-13: Quick guide to the changeover value, page 2

9.4 Control terminal diagram

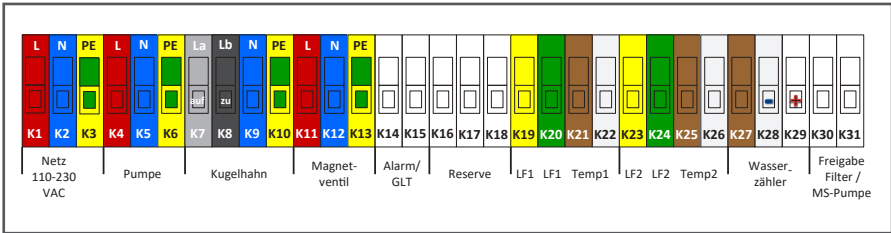

Fig. 9-14: Control terminal diagram

9.5 Terminal diagram for measuring probes LF1/LF2

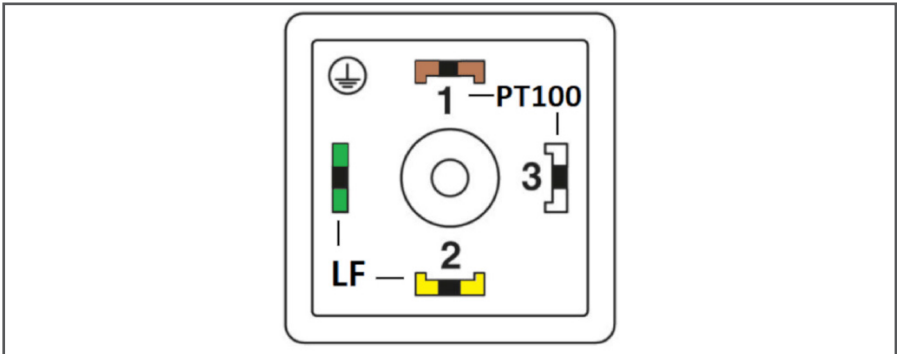

Fig. 9-15: Terminal diagram for measuring probes LF1/LF2

10

List of illustrations

Fig. 3-1: Overview of the components of the Racun 100 Advanced	18
Fig. 3-2: Detailed views	19
Fig. 3-3: Components of the control unit	21
Fig. 3-4: SD card slot	21
Fig. 3-5: Menu structure of the control unit	22
Fig. 3-6: Flow chart with status displays	23
Fig. 3-7: The fine filter in dismantled condition	24
Fig. 4-8: Bypass connection diagram	29
Fig. 9-9: View of magnetic flux filter	52
Fig. 9-10: View of the inner part of the magnetic flux filter	52
Fig. 9-11: Magnetic flux filter characteristic curve	53
Fig. 9-12: Quick guide to changeover value, page 1	55
Fig. 9-13: Quick guide to changeover value, page 2	56
Fig. 9-14: Terminal diagram for control	57
Fig. 9-15: Terminal diagram for measuring probes LF1/LF2	57

Enter the date of commissioning here: ___ / ___ / ___

Name of the installer: _____

Telephone number of the installer: _____

EG-Konformitätserklärung



EG-Konformitätserklärung

gemäß der EG-Maschinen-Richtlinie 2006/42/EG vom 17. Mai 2006, Anhang II A

Hiermit erklären wir, dass die nachstehend bezeichnete Maschine in ihrer Konzeption und Bauart sowie in der von uns in Verkehr gebrachten Ausführung den grundlegenden Sicherheits- und Gesundheitsanforderungen der EG-Richtlinie 2006/42/EG entspricht. Bei einer mit uns nicht abgestimmten Änderung der Maschine verliert diese Erklärung ihre Gültigkeit.

Hersteller:

UWS Technologie GmbH
Sudetenstraße 6
91610 Insinggen
Telefon: 09869 919100
E-Mail: info@uws-technologie.de

Beschreibung der Maschine:

- Funktion: Heizwasseraufbereitungsgerät
- Typ: Heaty Racun 100 Advanced
- Artikel Nr.: 100488-SL
- Masse: 40 kg
- Baujahr: 2023
- Elektroanschluss: 230V, 0,5 kW, 50/60 Hz

Es wird die Übereinstimmung mit weiteren, ebenfalls für das Produkt geltenden Richtlinien/Bestimmungen erklärt:

- EMV-Richtlinie (2014/30/EU) vom 26. Februar 2014
- RoHS-Richtlinie (2011/65/EU) vom 08. Juni 2011
- Niederspannungs-Richtlinie (2014/35/EU) vom 26. Februar 2014

Angewandte harmonisierte Normen insbesondere:

- DIN EN ISO 12100 Sicherheit von Maschinen – Grundbegriffe, allgemein Gestaltungsleitsätze, Risikobeurteilung und Risikominderung
- DIN EN 349 Sicherheit von Maschinen; Mindestabstände zur Vermeidung des Quetschens von Körperteilen
- DIN EN 809 Pumpen und Pumpenaggregate für Flüssigkeiten — Allgemeine sicherheitstechnische Anforderungen
- DIN EN 1037 Sicherheit von Maschinen – Vermeidung von unerwartetem Anlauf
- DIN EN ISO 13849-1 Sicherheit von Maschinen – Sicherheitsbezogene Teile von Steuerungen- Teil 1: Allgemeine Gestaltungsleitsätze
- DIN EN ISO 13857 Sicherheit von Maschinen – Sicherheitsabstände gegen das Erreichen von Gefährdungsbereichen mit den oberen und unteren Gliedmaßen
- DIN EN ISO 14120 Sicherheit von Maschinen – Trennende Schutzeinrichtungen – Allgemeine Anforderungen an Gestaltung, Bau und Auswahl von feststehenden und beweglichen trennenden Schutzeinrichtungen
- DIN EN 60335-1 Sicherheit elektrischer Geräte für den Hausgebrauch und ähnliche Zwecke — Teil 1: Allgemeine Anforderungen

Bevollmächtigter für die Zusammenstellung der Technischen Dokumentation:

Thomas Schleep, siehe Herstelleradresse

Ort/Datum: Insinggen, 25.10.2023

Angabe zur Person des Unterzeichners:

Thomas Schleep, Geschäftsführer

Unterschrift:

our water. safe.

Your contact:

© UWS Technologie GmbH - All rights reserved

Version 1

Reprinting, including individual passages, is prohibited. The copyright and all rights are held by UWS Technologie GmbH.

Translation, reproduction, storage and distribution, including transfer to electronic data carriers and storage in electronic media, is not permitted without prior written consent and is punishable by law.

No claims can be made on the basis of the information or illustrations provided.

We reserve the right to make changes in technology, form and equipment.

No liability is assumed for errors and misprints.

